

The following features are available in this PDF document.



Quick Keyword Search

Enter the keyword in the search box and hit the search button



Quick Jump between Chapters

Click the title of a specific chapter on the Contents to jump to it

*Reading software such as Adobe Reader is needed to support the functions above.



WEEBILL 2

User Guide

Contents

■ Product List	
Product List.....	1
■ Get to Know WEEBILL 2	
Get to Know WEEBILL 2.....	3
■ Battery and Charging	
Battery and Charging.....	5
■ Installation and Balance Adjustment	
Mount the Tripod.....	6
Mount the Camera.....	7
Balance the Stabilizer.....	9
■ How to Use WEEBILL 2	
Buttons Description.....	12
Touch Screen Introduction.....	13
How to Use the Touch Screen.....	14
Motor Torque Adjustment.....	17
Stabilizer Mode Description.....	19
Manual Reposition.....	22
Use with TransMount Image Transmission Transmitter AI (hereinafter referred to as "transmitter AI").....	23
■ How to Use the App	
Download the App.....	27
Connect to the App.....	27
App Features.....	28
■ Calibration and Firmware Upgrade	

When to Calibrate the Stabilizer	29
Six-side Calibration	29
Motor Fine-Tuning	31
Stabilizer Firmware Update	32

■ Product Specifications

■ Disclaimer and Warning

Reading Tips	35
Warnings	35
Safe Operation Guidelines	36

■ Warranty Terms

Warranty Period	38
Warranty Exclusions	38
Warranty Claim Procedure	38

■ Contact Card

Product List

Before using this product, please check carefully that all the following items are included in the product package. In case that any item is found missing, please contact ZHIYUN or your local selling agent.



Stabilizer x 1

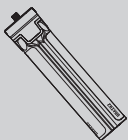
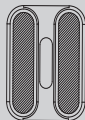

Quick Release Plate x 1

TransMount WEEBILL 2 Handheld Tripod
x 1

Backing Base x 1

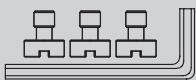

1/4 Screw x 3 / M4 Wrench x 1*

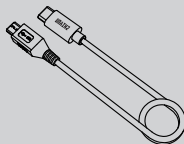
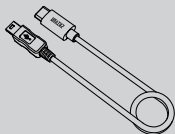
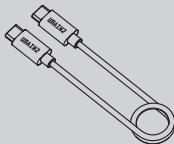
Type-C to Micro USB LN-MBUC-A02
Camera Control Cable x 1Type-C to Mini USB LN-NBUC-A01
Camera Control Cable x 1Type-C to Type-C LN-UCUC-A02
Camera Control Cable x 1

Product List

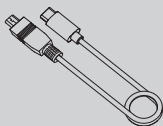

Type-C to Multi USB LN-UCUS-A03
Camera Control Cable x 1

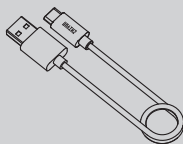

USB Type-C Cable x 1



Quick Start Guide x 1

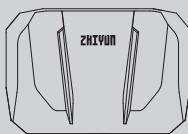

Storage Box x 1

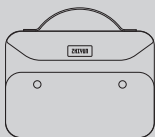

TransMount WEEBILL Carrying Case x1*

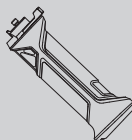

Sling Grip Handle x1*



TransMount Image Transmission
Transmitter AI x1**

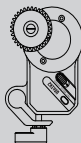

TransMount Focus/Zoom Control Motor 2.0
x1**

** Only in WEEBILL 2 COMBO or WEEBILL 2 PRO

*** Only in WEEBILL 2 PRO

Get to Know WEEBILL 2

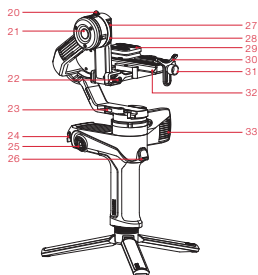
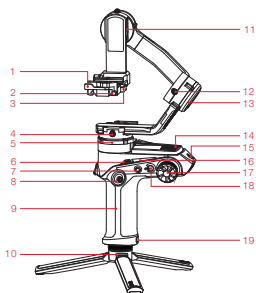

1. Quick Release Plate Latch
2. Quick Release Plate Safety Lock
3. Quick Release Plate Base Latch
4. Pan Axis Lock Switch
5. Pan Axis Motor
6. Power Button
7. Photo/Video Button
8. Joystick
9. Handle
10. Tripod
11. Camera Control Port
12. Roll Axis Lock Switch
13. Roll Axis Motor
14. Touch Screen (Retract State)
15. 1/4" Screw Hole
16. Indicator Lights
17. Control Wheel
18. Mode Switch (PF/F/L)

19. Type-C Charging/Upgrade Port
20. Tilt Axis Lock Switch
21. Tilt Axis Motor
22. Level Mount Lock Screw
23. Pan Axis Latch
24. Sling Grip Handle Latch
25. 1/4" Screw Thread with Rosette Mount
26. Trigger Button
27. Follow Focus Control Port
28. Follow Focus/Image Transmission Control Port
29. Camera Backing Base
30. Lens Support
31. Lens Support Lock Screw
32. Quick Release Plate
33. Touch Screen (Launch State)

Ports Introduction

No.	Port	Description	Using cable
11	Camera Control Port	Connect to camera	Control cable corresponding to the camera port
		Connect to TransMount Image Transmission Transmitter 2.0	Type-C to Type-C (LN-UCUC-A02 straight) or Type-C to Type-C (LN-UCUC-A03 straight Transmitter To stabilizer Only, with yellow tag)
19	Type-C Charging/ Upgrade Port	Connect to charger	USB Type-C cable
		Connect to computer for WEEBILL 2 firmware upgrade	
27	Follow Focus Control Port	Connect to TransMount Focus/Zoom Control Motor 2.0	Type-C to Type-C (LN-UCUC-D02 curved)
28	Follow Focus/ Image Transmission Control Port	Connect to TransMount Focus/Zoom Control Motor 2.0	Type-C to Type-C (LN-UCUC-D02 curved)
		Connect to TransMount Image Transmission Transmitter AI	Type-C to Type-C (LN-UCUC-A03 straight. Transmitter To stabilizer Only, with yellow tag)

Battery and Charging

WEEBILL 2 adopts built-in battery. Use provided USB Type-C cable to connect with the USB charger (not provided) to charge the WEEBILL 2. It is recommended to use USB chargers that meet the PD policy. (supports 24W at most). When the four indicator lights stay solid, the charging is completed.

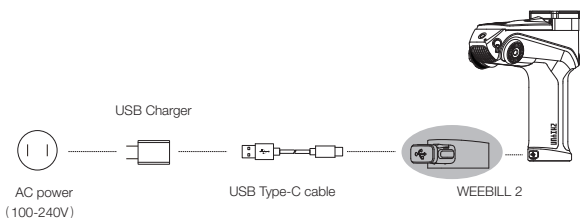

⚠ WEEBILL 2 is equipped with batteries of high energy density, which may cause fire, economic loss or personal injury when improperly stored or handled. Please read the disclaimer and warning herein as well as the description on the battery label carefully before using the batteries.

Mount the Tripod

Mount the tripod to the bottom of the WEEBILL 2 handle, then unfold the tripod and place the WEEBILL 2 on a flat surface.

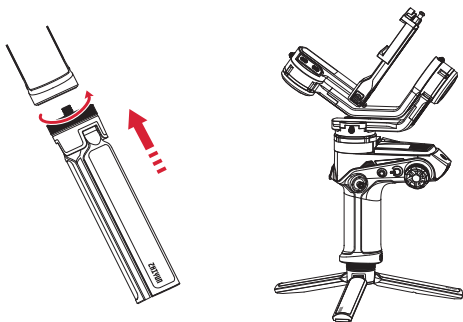

You can also mount the tripod onto the position as shown in the image to enter Sling Mode.

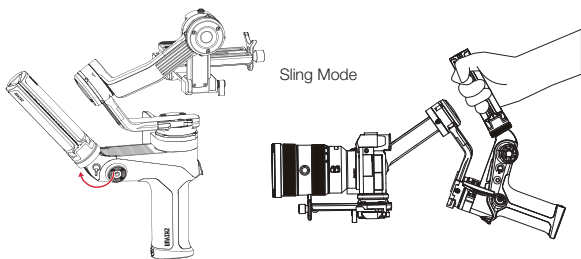

 When using the sling mode, please make sure to put the sling grip handle latch to the lock position.

Mount the Camera

- ① Before mounting the camera, make sure it is prepared ahead of time. Remove the lens cap and make sure the camera's battery and memory card are already in place.
- ② Each axis of the stabilizer is equipped with a lock switch. You can use these lock switches to lock the axes for convenient installation and storage. The storage state is the default state. Please unlock three axes, expand the stabilizer as shown in the image and lock the axes again for convenient camera installation.

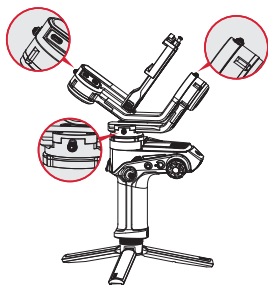

Lock state for storage

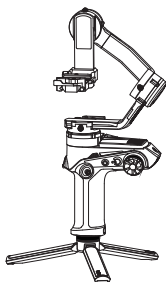

Lock state for installation

1. Mount the camera on the camera backing base. Tighten the bottom screw and ensure a firm installation.

① You may decide whether or not to use the camera backing base depending on your camera-lens combo. You will need the camera backing base in the following situations:

- ① When mounting external follow focus motor.
- ② When using lenses with larger diameters, such as the Canon RF24-70mm F2.8 L IS USM lens.

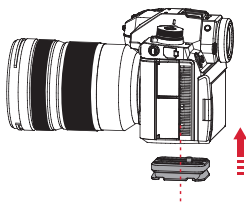

2. Mount the camera on the quick release plate. In order to be stable, when mounted with a longer or heavier lens, please mount the lens support and make sure a firm installation.

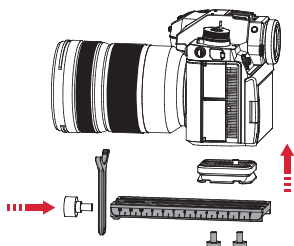

3. Loosen the quick release plate latch. Take the quick release plate with the camera mounted on it and mount it on the stabilizer. Make sure it clicks into the safety lock, and make sure a firm installation.

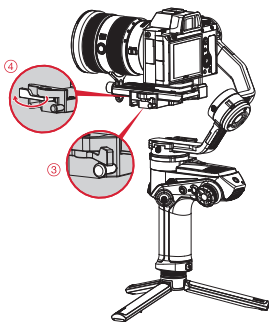
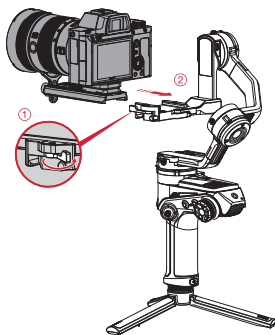

-  When detaching the camera from the stabilizer, loosen the quick release plate latch, press the safety lock, and push out the whole quick release plate.

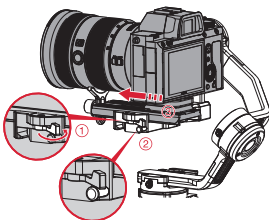

4. Choose the correct camera control cable according to the camera model.
Connect the USB control port of the camera and the camera control port of WEEBILL 2.

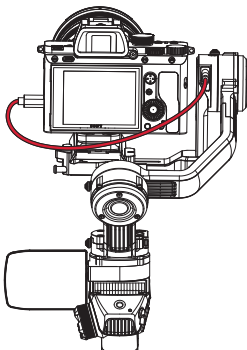

-  For details of supported camera model for WEEBILL 2, please visit the official website of ZHIYUN (www.zhiyun-tech.com) and check the "WEEBILL 2 Camera Compatibility List".

Balance the Stabilizer

1. Horizontal Balance of the Tilt Axis

Unlock the tilt axis. Loosen the quick release plate latch. Push the quick release plate to move forward or backward until the camera can stay still and almost level with its lens facing front. Complete this step by tightening up the quick release plate latch.

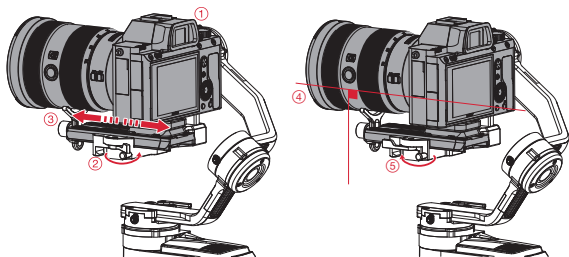

2. Vertical Balance of the Tilt Axis

Unlock the tilt axis, make the lens face up, loosen the level mount lock screw. Push the whole level mount to move forward or backward. Push until the camera can stay still with the lens facing up (i.e. the camera stays still and vertical to the ground). Complete this step by tightening up the screw.

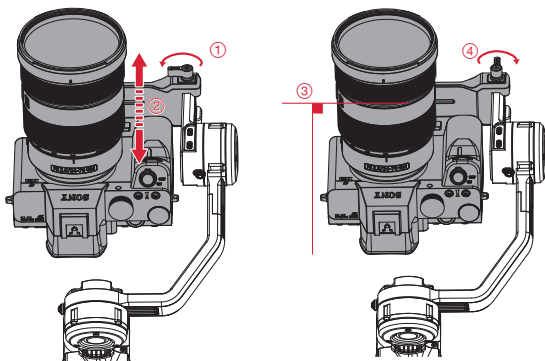

3. Roll Axis Balance

Unlock the roll axis and the quick release plate latch, push the camera to move left or right until the camera can stay still and horizontal to the ground (as shown below). Complete this step by tightening up the latch.

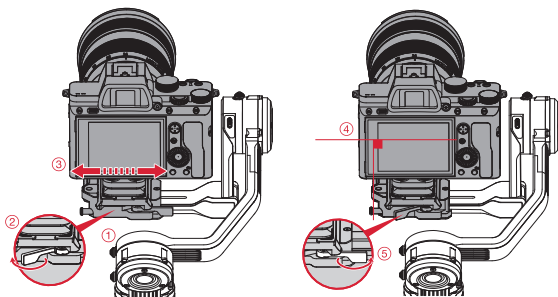

4. Pan Axis Balance

Unlock the pan axis, loosen the pan axis latch, hold and slightly tilt the handle, push the pan axis to move left or right until the pan axis can stay still in any position. Complete this step by tightening up the pan axis latch.

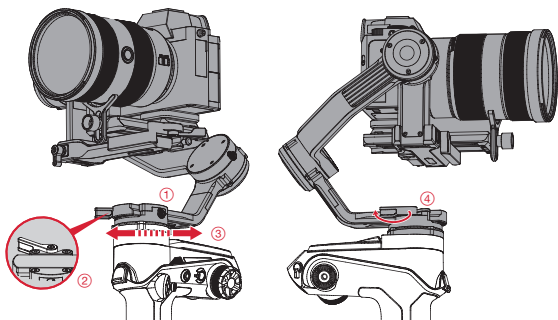

 After balancing WEEBILL 2, the motor torque needs to be adjusted for proper function. For the adjustment details, please see the methods introduced in "Motor Torque Adjustment".

Buttons Description

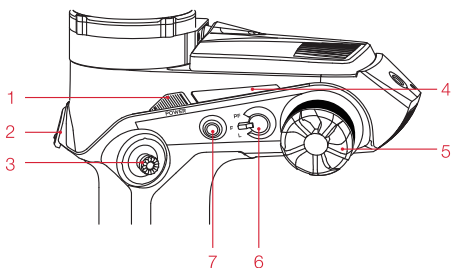
**1. Power Button**

- Press and hold: Power on/off
- Single press: Turn on/off the screen
- Double press: Sleep mode/wake mode for the stabilizer motor

2. Trigger Button

- Single press: Enable/disable SmartFollow (Need to mount TransMount Image Transmission Transmitter AI Version)
- Double press: Reposition
- Triple press: Selfie Mode
- Press and hold: Enter POV mode. Release the button to return to the previous mode.

3. Joystick

Control the stabilizer to rotate.

4. Indicator Lights**5. Control Wheel**

Can customize on the touch screen (Roll axis/Aperture/ISO/Shutter/Electronic Focus/Zoom Control/Focus Control)

6. Mode Switch

- Three modes to switch: Pan Follow Mode (PF)/Follow Mode (F)/Lock Mode (L)

7. Photo/Video Button

- Half press: Auto camera focus for some of the cameras
- Single press: Start/stop shooting video
- Press and hold: Take photo

Touch Screen Introduction

Launch/Retract the Touch Screen

Launch the touch screen before using it. Please rotate in the correct direction as shown in the image. The rotate angle for the touch screen is limited, please rotate it properly to avoid damaging the touch screen. Please retract the touch screen when you don't need to use it.

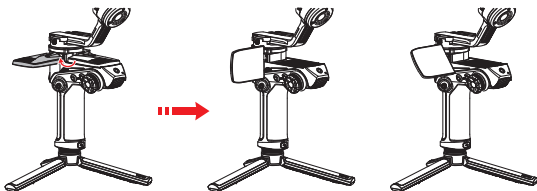

Launch



Retract

How to Use the Touch Screen

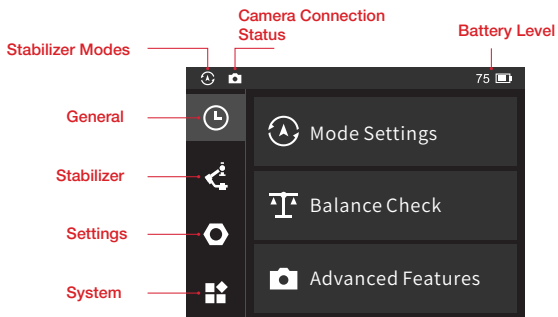

Main Page (Set as default)

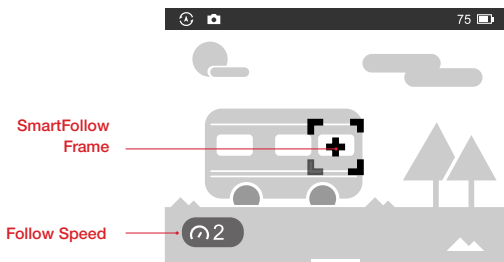

Swipe down at the top of the screen:
Image transmission interface (Need to mount
TransMount Image Transmission AI version)

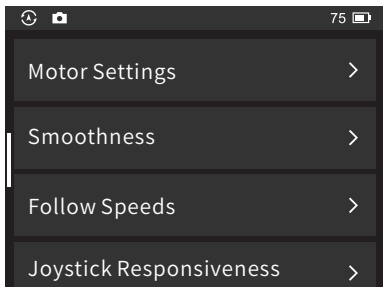

Swipe left at sub menu: Return to the previous menu

Touch screen menu introduction

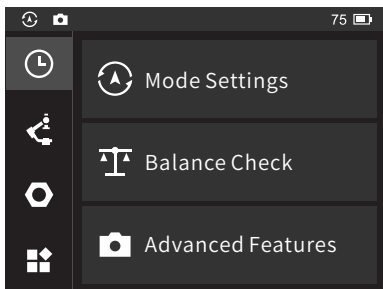

General:

1. Mode Settings: For selecting stabilizer modes. Available modes are: Pan Follow Mode (PF)/Lock Mode (L)/POV Mode (POV)/Portrait Mode/Go Mode (GO)/Vortex Mode (V)
2. Balance Check: To see the balance status of three stabilizer axes.
3. Advanced Features: For setting Panorama/Timelapse/Motionlapse/V Mode.

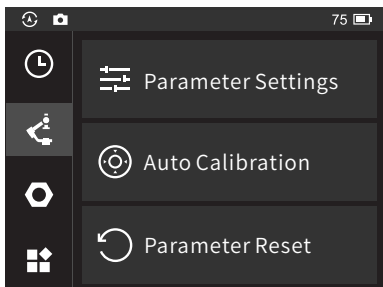

Stabilizer:

1. Parameter Settings: For setting motor torque/smoothness/follow speed/joystick responsiveness/deadband.(You can customize the parameters or set them to be "Low", "Medium", or "High" in default.)
2. Auto Calibration: To perform auto calibration after the balancing is finished.
3. Parameter Reset: Tap to reset to the default parameters.

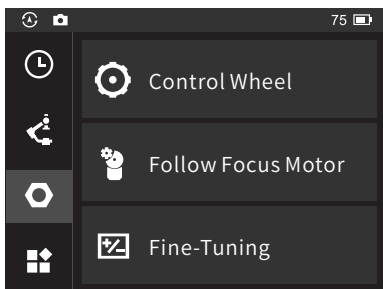

Settings:

1. Control Wheel: Customize the function of the control wheel. Available functions are: roll axis/aperture/ISO/shutter/electronic focus/focus control/zoom control
2. Follow Focus Motor: Set the AB point/sensitivity of the follow focus motor (A/B point setting is only available when the ZHIYUN external follow focus motor is connected correctly)
3. Fine-Tuning: Fine-tune the tilt/roll axis.

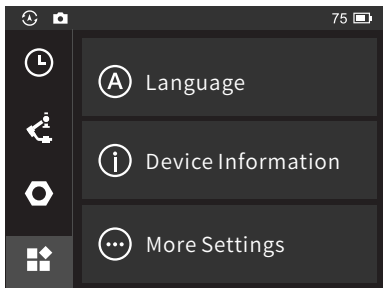

System:

1. Language: Switch the language of the touch screen menu (simplified Chinese/English)
2. Device Information: See the device information such as device name/device model/SN/firmware version/UI version
3. More Settings: Enable/disable the power supply from WEEBILL 2 to transmission system.

Motor Torque Adjustment

After balancing WEEBILL 2, the motor torque needs to be adjusted for proper function. You can adjust the motor torque according to the weight of your camera and lens, so that the WEEBILL 2 can be used in its ideal state. Following are three methods for adjustment. It is recommended to use auto calibration.

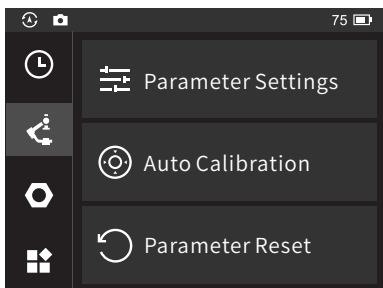

1. **Auto calibration:** Auto calibration will adjust the motor torque according to the weight of the carried camera and lens. Select "Stabilizer"- "Auto Calibration", tap "Start" to enter calibration. You can see the calibration progress on the screen.

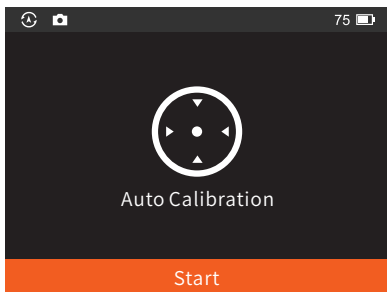

- 💡 When performing auto calibration, please make sure that the three axes are unlocked and the stabilizer is straightly put on a flat surface. Please don't touch the stabilizer when in calibrating. You can see the calibration progress on the screen.

2. **Parameter Settings – Motor Settings:** Three levels (Low/Medium/High) are provided. Select the appropriate level according to the weight of the carried camera and lens.

Select "Customize" to customize the motor torque.

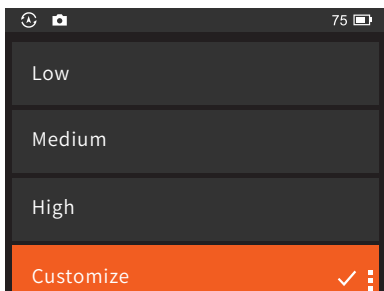

- 💡
- ① If the motor torque is too low/high for the payload, the camera will shake and affect the stabilizer performance. Please choose proper motor torque.
 - ② It is recommended to use auto calibration. If the stabilizer is not yet in the ideal state after the auto-calibration, you can use the customized adjustment or choose the level of the motor torque to be high/medium/low.
 - ③ When the camera lens is changed, please balance the stabilizer again and adjust the motor torque with the methods above.

Stabilizer Mode Description

💡 Motors circled in red are free to move in line with the movement of the stabilizer handle while motors circled in grey are locked.

Pan Follow mode (PF):

The tilt axis and roll axis motors are locked, and the camera rotates with the handle while panning horizontally. Push the joystick up/down to control the tilt axis angle, and push it left/right to control the pan axis of the camera.

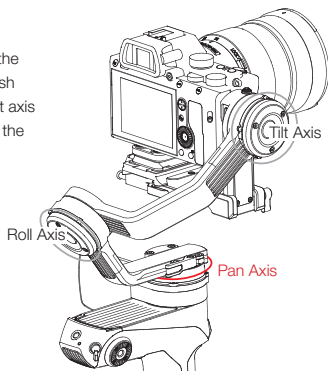

Lock mode (L):

All three motor angles are locked, and the camera orientation will not move with the rotation of the handle. Push the joystick up/down to change the tilt angle of the camera and left/right to change the horizontal orientation of the camera.

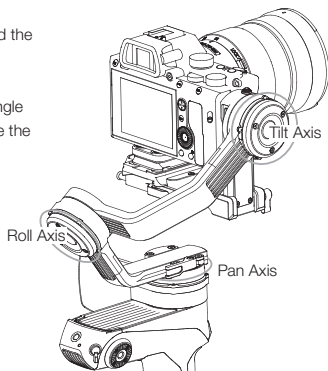

Follow mode (F):

The roll axis motor is locked, and the tilt axis and pan axis motors follow the rotation of the handle. Push the joystick up/down to change the tilt angle of the camera and left/right to change the horizontal orientation of the camera.

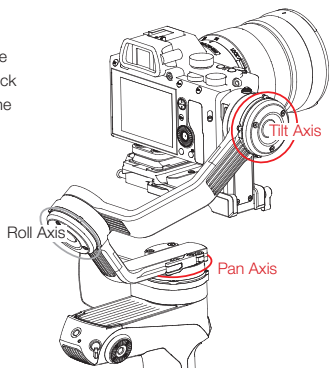

Point of View mode (POV):

All three motors move when the handle is rotated.

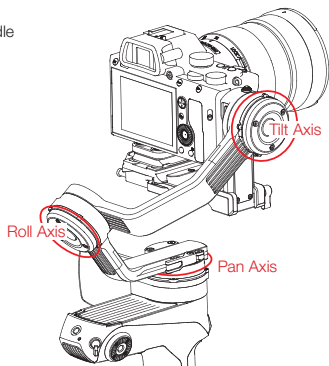

Vortex mode (V):

The tilt axis motor rotates upward by 90°, and the tilt axis, roll axis and pan axis motors follow the rotation of the handle. Push the joystick to the left/right to control the rotation of the pan axis.

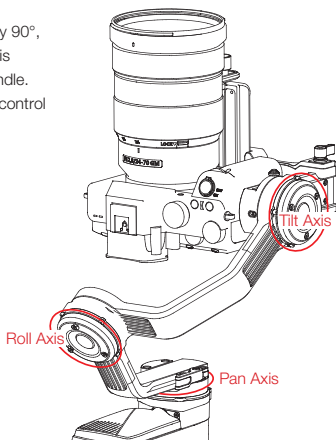
**Go mode (GO):**

The roll axis motor is locked, and the tilt axis and pan axis motors quickly follow the rotation of the handle.

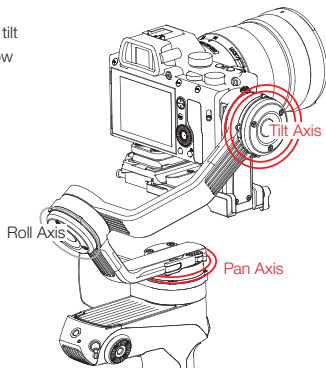

Portrait mode

The tilt axis motor rotates upward by 90° and the pan axis rotates by 90°. You can enter this mode for vertical shooting.

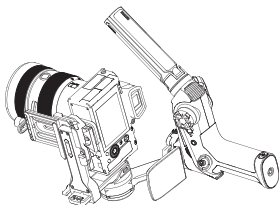

Manual Reposition

In Pan Follow mode (PF) and Lock mode (L), the camera can be rotated by a certain angle by hand. Hold it for 2s and the camera angle will be fixed at that angle after you release the camera.

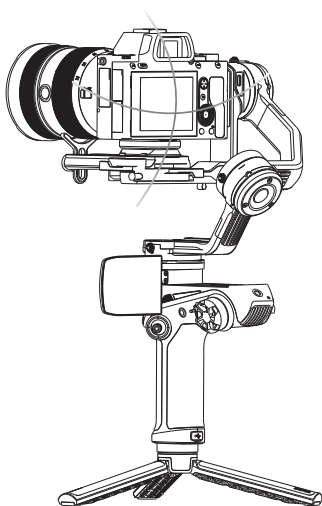

Use with TransMount Image Transmission Transmitter AI (hereinafter referred to as "transmitter AI")

Install

1. Take out the transmitter mounting plate, mount the transmitter mounting plate to the bottom of the WEEBILL 2's level mount (note the direction of the notch), and use the wrench to tighten the screws.

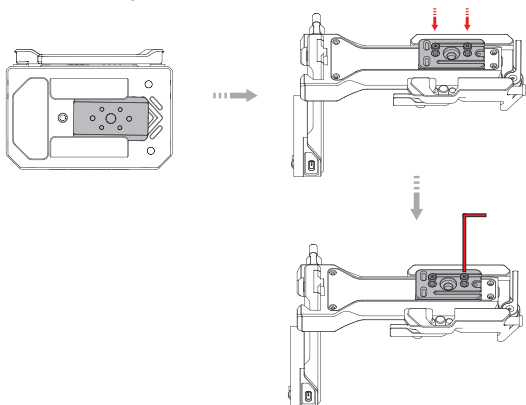

2. Place the transmitter AI with the mounting plate slot facing up, align the transmitter mounting plate, push the transmitter AI toward the tilt axis motor until it clicks into the safety lock to make sure a firm installation.

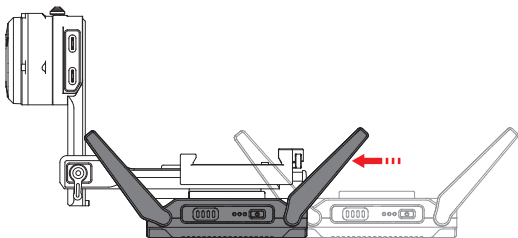

 In order to have the best image transmission, please rotate the antenna to the position as shown in the image.

Connect

1. Take out the stabilizer-only cable (LN-UCUC-A03, Transmitter To stabilizer Only), connect with the follow focus/image transmission control port of the WEEBILL 2 and the Type-C charging/communication port of the transmitter AI.

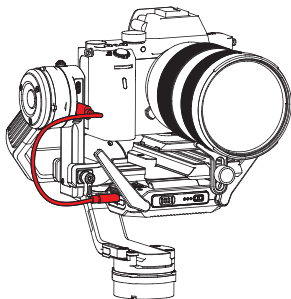

- ⚠ ① Do not mix LN-UCUC-A03 cable with LN-UCUC-A02. LN-UCUC-A03 cable is for the stabilizer to connect with transmitter AI, while LN-UCUC-A02 is a camera control cable. See the image to know where to check the name and the model of the cable. (LN-UCUC-A02 has a black tag, LN-UCUC-A03 has a yellow tag.)

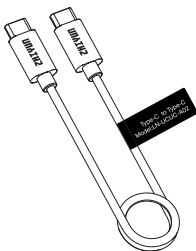

LN-UCUC-A02

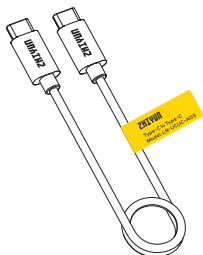

LN-UCUC-A03

- ② When used with TransMount Image Transmission Transmitter 2.0, its Type-C charging/communication port has to be connected with the camera control port of WEEBILL 2 and you can't view the camera footage and use SmartFollow via WEEBILL 2's touch screen. Please use with TransMount Image Transmission Transmitter AI if you want to do so.

2. Take out the camera control cable corresponding to the USB port model of the camera, connect to the camera control port of the transmitter AI and the USB port of the camera. Use the HDMI cable corresponding to the HDMI port model of the camera, connect to the HDMI video input port of the transmitter AI and the HDMI output port of the camera.

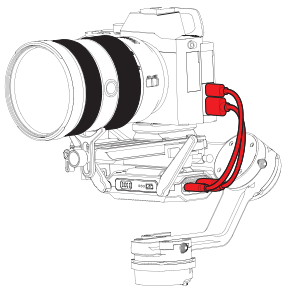

- ① It is recommended that the WEEBILL 2 and transmitter AI be shut down and powered off before plugging in or out the cable. The actual color of the cable is black. The red color used in the manual is only used for illustrative purposes.
- ② To see how you can connect the camera control cable and the HDMI cable, please visit the official website of ZHIYUN (www.zhiyun-tech.com) to see "TransMount Image Transmission Transmitter AI Camera Compatibility List".
- ③ After installing the device, you need to adjust the balance of the WEEBILL 2.

Use

After installing, power on the stabilizer, camera and transmitter AI and enter the main page of the touch screen. Swipe down at the top of the screen to view the real-time footage of the camera and enable SmartFollow. When using SmartFollow, the stabilizer can automatically follow the movement of the target to keep the target at the center of the frame.

SmartFollow using method:

- A. Use the SmartFollow frame at the center of the screen frame to aim at the target. Single press the trigger button to enable SmartFollow. You can also mark the target on the screen.
- B. Face the camera, make the palm gesture and hold for 1-2s, and the stabilizer will automatically enable SmartFollow and start filming. Make the palm gesture again to stop the SmartFollow and end the shooting.

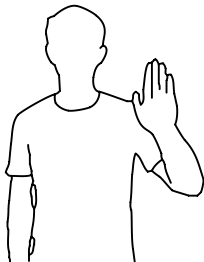

- 💡 You can customize the follow speed. If it's too high, the stabilizer will shake. If it's too low, the stabilizer will lose the target when following targets with high-speed movement so that the shooting will not reach an ideal state. For ideal performance, please adjust the speed according to the actual shooting scenarios.

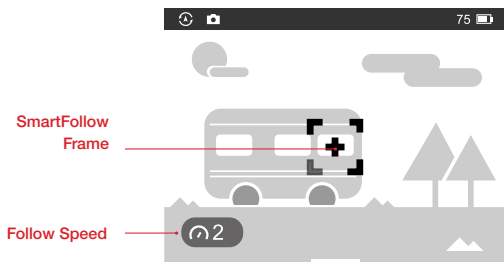

Download the App



Scan the QR code on the left (Android 5.0 and above or iOS 9.0 and above) or search "ZY Play" in the App Store or Google Play to download the app.

- ① "ZY Play" is an app dedicated to WEEBILL 2. When activated WEEBILL 2 via "ZY Play", you can also use it for firmware upgrade, virtual joystick control, motion sensor control, long-distance camera footage monitoring and camera parameters adjustment, etc. (Needs to mount image transmission system)
- ② ZY Play is subject to updates without notice. Please always refer to the latest version.

Connect to the App

1. Power on WEEBILL 2 and turn on Bluetooth on the smartphone.
2. Launch the "ZY Play" app. Select the WEEBILL 2 page and tap to connect. Select the Bluetooth name of your WEEBILL 2 to connect. (the WEEBILL 2 Bluetooth name can be found on the side of the tilt axis USER ID: XXXX).
3. Activation on the ZY Play app is required if the WEEBILL 2 is being used for the first time. Otherwise you're not able to use the advanced features in ZY Play. Internet connection is required.
4. After the activation succeeds, you can enter the feature interface of ZY Play App.

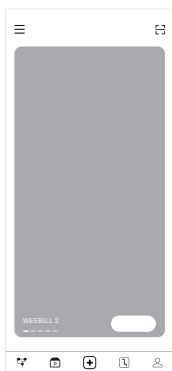
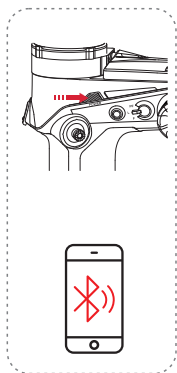

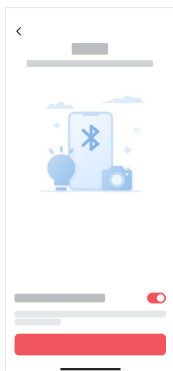
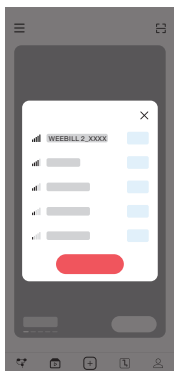

App Features



When to Calibrate the Stabilizer

Please calibrate the stabilizer when necessary.

Calibration Reason	How to calibrate
1. Slight deviation is found in the level position after the initialization of the stabilizer. 2. The stabilizer has not been used for a long time. 3. The stabilizer undergoes significant temperature difference in operation Environments.	Six-side calibration
Slight deviation is found in the tilt or roll angle of the camera in level position after initialization and six-side calibration of the stabilizer.	Motor fine-tuning

Six-side Calibration

1. Six-side calibration via APP:

According to the method introduced in "How to Use the App", please connect the stabilizer to the APP, and enter "Settings"- "Six-side Calibration", then conduct the six-side calibration according to the prompt.

2. Six-side calibration via "Zhiyun Gimbal Tools":

Power on the stabilizer and enter standby mode. Connect the charging/upgrade port of the stabilizer to the computer with the Type-C USB cable, Open "Zhiyun Gimbal Tools", click "open" on the top and click "calibration" on the bottom. Please conduct the process according to the following steps. A "√" mark will appear after the calibration is completed.

Notes:

- ① Please refer to the six-side calibration steps below. After the calibration is completed, please restart the stabilizer.
- ② In simple terms, six-side calibration is to place all six sides of the camera mounting plate in vertical to a level surface respectively.

STEP 1

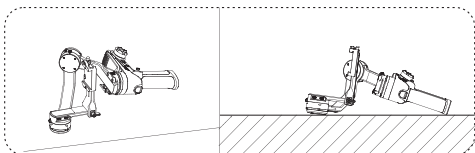

STEP 2

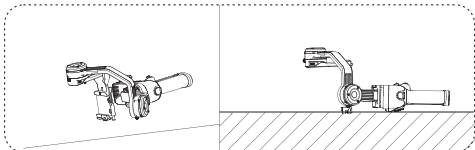

STEP 3

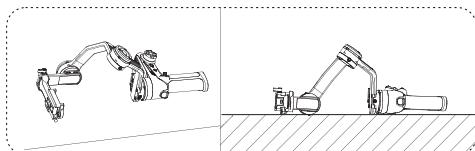

STEP 4

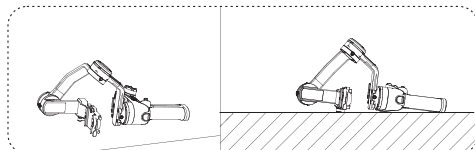

STEP 5

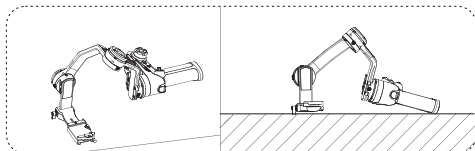

STEP 6

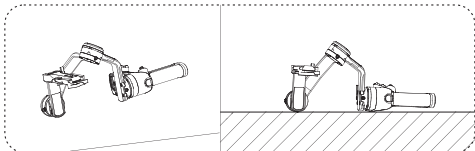

Motor Fine-Tuning

Select "Settings" - "Fine-Tuning", set the fine-tuning value of the tilt axis and roll axis according to actual needs.

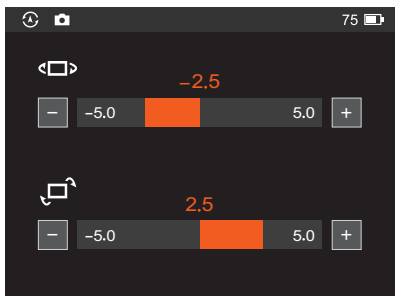

Stabilizer Firmware Update

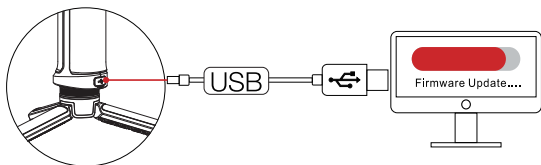

Method One:

1. Connect the charging/upgrade port at the bottom of the WEEBILL 2 handle to the computer with the Type-C USB cable, power on WEEBILL 2.
2. Visit the official website of ZHIYUN (www.zhiyun-tech.com), go to the WEEBILL 2 product page, click "Download", find the USB driver, the calibration upgrade tool and the firmware and download. (USB drivers are not required for Mac OS systems)
3. Install the driver, unzip the firmware for the documents with the ".ptz" file extension.
4. Open "Zhiyun Gimbal Tools", click "Open", click "Firmware Upgrade". Click "Browse" under "Path" to select the latest firmware downloaded (with the ".ptz" file extension), and click "Upgrade" at the bottom to upgrade firmware.

Method 2:

Upgrade via the app. According to the method introduced in "How to Use the App", connect the WEEBILL 2 to the app. If a firmware update prompt pops up on the app, please follow the instructions to upgrade.

- ① When upgrading with Method 1, please wait until the touch screen displays that the upgrade is finished, then you can plug out the USB Type-C cable.
- ② Before upgrading the firmware, please ensure that the WEEBILL 2 stabilizer has more than 50% power remaining. You will not be able to exit the app interface or access the back-end during the upgrading process. Pay attention to the prompts on the app.

Product Model: CR120

	Min.	Standard	Max.	Remark
Operation Voltage	9.8V	11.1V	12.6V	
Operation Current	160mA	-	6000mA	
Charging Voltage	-	15V	-	PD Fast Charge: 15V
Charging Current	-	1.6A	-	
Output Voltage	-	5V	-	
Output Current	-	1.5A	-	Camera Control Port
Following Deviation in Static State	$\pm 0.01^\circ$	-	$\pm 0.04^\circ$	
Following Deviation in Motion State	$\pm 0.05^\circ$	$\pm 0.1^\circ$	$\pm 0.3^\circ$	
Tilt Mechanical Range	-150°	-	+190°	
Roll Mechanical Range	-260°	-	+80°	
Pan Mechanical Range	-	360°	-	Unlimited Rotation
Controllable Tilt Angle	-80°	-	+160°	
Controllable Roll Angle	-35°	-	+35°	
Controllable Pan Angle	-180°	-	+180°	
Operation Temperature	-10°C	25°C	45°C	
Battery Capacity	-	2600mAh	-	Three 18650 Li-Ion Batteries
Battery Runtime	-	9h	-	Lab Data 1
Charging Time	-	1.6h	-	Lab Data 2
Charging Ambient Temperature	5°C	-	40°C	
Bluetooth		Bluetooth 5.0		

EIRP	<10dBm	
Operation Frequency	2.4 GHz	
Camera Charging	Able to charge for 5V / 1.5A cameras	
1/4" Rosette Mount Screw Thread Carry Weight	Carry weight \leq 1000g, Arm \leq 100mm	Meet both of the standards
Touch Screen Size	2.88 inches	
Compatible Models	See camera compatibility list	

Lab Data 1: The above data is collected at a specified temperature of 25°C . The WEEBILL-2 is fully charged with 18650-2600mAh battery and mounted with Nikon D850+Sigma 24-70mm f/2.8L DG. The WEEBILL-2 is properly balanced and put on a flat surface. The handle screen is on and solid. The maximum runtime is 9h.

Lab Data2: This test is conducted with a 24W PD Fast Charge at a specified temperature of 25°C . The charging time is 1.6h. The actual charging time varies with environmental factors. In addition, the lower the temperature, the longer the charging time.

All the data in this guide is collected from internal experiments of ZHIYUN laboratories. Under different scenarios, the above data is subject to a margin of error. Please refer to actual use of this product.

Thank you for purchasing WEEBILL 2. The information contains herein affects your safety, legitimate rights and obligation. Please read this instruction carefully to ensure proper configuration before use. Failure to read and follow this instruction and warnings herein may result in serious injury to you or bystanders, or damage to your device or property. Guilin Zhishen Information Technology Co., Ltd (hereinafter referred to as "ZHIYUN") reserves all rights for final explanation on this instruction and other documents related to WEEBILL 2. The information is subject to update without notice. Please visit www.zhiyun-tech.com to obtain the latest product information.

By using this product, you hereby signify that you have read this document carefully and that you understand and agree to abide by the terms and conditions herein. You agree that you are solely responsible for your own conduct while using this product, and for any consequences thereof. You agree to use this product only for purposes that are proper and in accordance with all terms, precautions, practices, policies and guidelines ZHIYUN has made and may make available.

ZHIYUN accepts no liability for damage, injury or any legal responsibility incurred directly or indirectly from the use of this product. Users shall observe safe and lawful practices including, but not limited to, those set forth herein.

ZHIYUN™, TransMount™ are the trademark of Guilin Zhishen Information Technology Co., Ltd and its affiliates. All product names or trademarks referred to herein are trademarks or registered trademarks of their respective holders.

Reading Tips

Legends



Hints and Tips



Important

Warnings

Read the ENTIRE User Guide to become familiar with the features of this product before operating. Failure to operate the product correctly can result in damage to the product or personal property and cause serious injury. This is a sophisticated product. It must be operated with caution and common sense and requires some basic mechanical ability. Failure to operate this product in a safe and responsible manner could result in injury or damage to the product or other property. This product is not intended for use by children without direct adult supervision. DO NOT use with incompatible components or in any way otherwise as mentioned or instructed in the product documents provided by ZHIYUN. The safety guidelines herein contain instructions for safety, operation and maintenance. It is essential to read and follow all of the instructions and warnings in the User Guide, prior to assembly, setup or use, in order to operate the product correctly and avoid damage or serious injury.

Safe Operation Guidelines

CAUTION:

1. WEEBILL 2 is a high-precision control device. Damage may be caused to WEEBILL 2 if dropped or subject to external force, and this may result in malfunction.
2. Make sure the rotation of the stabilizer axes is not blocked by external force when WEEBILL 2 is turned on.
3. WEEBILL 2 is not waterproof. Prevent contacts of any kind of liquid or cleaner with the WEEBILL 2. It is recommended to use dry cloth for cleaning.
4. Protect WEEBILL 2 from dust and sand during use.

WARNING

To avoid fire, serious injury, and property damage, observe the following safety guidelines when using, charging, or storing your batteries.

1. Prevent the batteries from coming into contact with any kind of liquid. Do not leave batteries out in the rain or near a source of moisture. Do not drop the battery into water. If the inside of the battery comes into contact with water, chemical decomposition may occur, potentially resulting in the battery catching on fire, and may even lead to an explosion.
2. If the battery catches fire, use sand or dry powder fire extinguisher immediately to put out the fire.
3. Never use non-ZHIYUN batteries. If replacement or backup is needed, please purchase new batteries from ZHIYUN's official website or authorized channels. ZHIYUN takes no responsibility for any damage caused by non-ZHIYUN batteries.
4. Never use or charge swollen, leaky, or damaged batteries. Never use or charge if the battery smells, or overheats (exceeding the maximum temperature of 160 ° F/71 ° C). If your batteries are abnormal, contact ZHIYUN or a ZHIYUN authorized dealer for further assistance.
5. The battery should be used within the temperature range from -10° C to 60° C. Use of battery in environments above 60° C may lead to a fire or explosion. Use of battery below -10° C may lead to serious battery damage.
6. Do not use the battery in strong electrostatic or electromagnetic environments. Otherwise, the battery protection board may malfunction.
7. Do not disassemble or use any sharp object to puncture the battery in any way. Otherwise, the battery may leak, catch fire or explode.
8. Do not mechanically strike, crush, or throw the battery. Do not place heavy objects on the battery or charger.
9. Electrolytes inside the battery are highly corrosive. In case of accidental contact

of any electrolytes with your skin or eyes, rinse immediately with water for at least 15 minutes and seek medical advice as soon as possible.

10. Do not use the battery if it has been involved in a crash or heavy impact.
11. Do not heat the battery and never put the battery in a microwave oven or in a pressurized container.
12. Do not place the battery on a conductive surface (such as a metal desk surface, eyeglasses, watch, jewelry, etc.)
13. Prevent use of wires or other metal objects that could cause positive and negative short-circuit to the battery.

Battery Charging

1. Do not put the battery and charger near flammable materials or on flammable surfaces (such as carpet or wood). Never leave the battery unattended during charging to prevent any accident.
2. Please disconnect the battery and the charger when fully charged.
3. Do not charge the battery immediately after use, because the battery temperature may be too high. Do not charge the battery until it cools down to normal room temperature. Charging the battery with its temperature over 45° C or lower than 0° C may lead to leakage, overheating, or damage.

Battery Storage

1. Keep batteries out of the reach of children and pets.
2. Do not leave the battery near heat sources such as a furnace or heater, or inside of a vehicle on hot days. Never expose the battery in any environment with temperature of over 60° C. The ideal storage temperature is 22° C-28° C.
3. Store batteries in a dry environment.
4. Do not leave the battery unused for too long after it has been completely discharged to prevent over-discharge of battery which may result in battery damage and permanent failure.

Battery Maintenance

1. Do not over-charge or over-discharge the battery, which will damage the battery;
2. The battery performance will be affected for not being used for a long time;
3. Never use the battery when the temperature is too high or too low;
4. Recharge and discharge every 3 months to keep the battery active.

Battery Disposal

Please fully discharge the battery before putting it in the designated recycling bin.

Batteries contain hazardous constituents and it is forbidden to put the battery in general waste bin. For related details please abide by the local laws and regulations on battery recycling and disposal.

Warranty Period

1. Customers are entitled to replacement or free repair service in case of quality deficits found in the product within 15 days upon receipt of the product.
2. Customers are entitled to free repair service from ZHIYUN for any product proven defective in material or workmanship that results in product failure during normal consumer usage and conditions within the valid warranty period, which is 12 months counting from the date of selling. However, warranty period varies by product component and country of purchase. Please contact our after-sales service team on the ZHIYUN official website or your place of purchase for detailed warranty information.

Warranty Exclusions

1. Products subjected to unauthorized repair, misuse, collision, neglect, mishandling, soaking, accident, and unauthorized alteration.
2. Products subjected to improper use or whose labels or security tags have been torn off or altered.
3. Products whose warranty has expired.
4. Products damaged due to force majeure, such as fire, flood, lightning, etc.

Warranty Claim Procedure

1. If failure or any problem occurs to your product after purchase, please contact a local agent for assistance, or you can always contact ZHIYUN's customer service through email at info@zhiyun-tech.com or website at www.zhiyun-tech.com.
2. Your local agent or ZHIYUN's customer service will guide you through the whole service procedure regarding any product issue or problem you have encountered. ZHIYUN reserves the right to reexamine damaged or returned products.

Customer information

Customer Name :

Contact No :

Address :

Sales Information

Sales Date :

Prod. Serial No :

Dealer :

Contact No ::

#1 Maintenance Record

Service Date :

Signature of Repairman :

Cause of Problem :

Service Result :

Solved

Unsolved

Refunded (Replaced)



Website



Weibo



Vimeo



Google+



Facebook
(Zhiyun Support)



Facebook
(Zhiyun Tech)



Youku



Youtube



Wechat



Instagram

Tel: +86 400 900 6868

USA Hotline: +1 808-319-6137,9:00-18:00 GMT-7,Mon-Fri

Europe Hotline: +49 (0) 61018132180,10:00-17:00 GMT+1,Mon-Fri

Web: www.zhiyun-tech.com

E-mail: service@zhiyun-tech.com

Address: 09 Huangtong Road, Tieshan Industrial Zone, Qixing District, Guilin, 541004, Guangxi, China.

Certificate of Quality

This product is confirmed to meet quality standards and permitted for sale after strict inspection.

QC Inspector: _____



Please download the latest version from www.zhiyun-tech.com

This document is subject to change without notice.

ZHIYUN™ is a trademark of ZHISHEN.

All other trademarks cited herein are the property of their respective owners.

Copyright © 2021 ZHISHEN. All rights reserved.

ZHIYUN-TECH.COM