

The following features are available in this PDF document.



Quick Keyword Search

Enter the keyword in the search box and hit the search button



Quick Jump between Chapters

Click the title of a specific chapter on the Contents to jump to it

*Reading software such as Adobe Reader is needed to support the functions above.



ZHIYUN CINEPEER CM15

User Guide

Contents

□ Brief Introduction	
Brief Introduction	1
□ Product List	
Product List	3
□ Get to Know ZHIYUN CINEPEER CM15	
Get to Know ZHIYUN CINEPEER CM15	4
□ Charging	
Charging	5
□ Installing Modifiers	
Installing/Removing the Diffuser	6
Installing/Removing ZHIYUN FIVERAY M20 Extension Bracket (hereinafter referred to as “extension bracket”)	6
Installing/Removing ZHIYUN FIVERAY M20 Diffuser (hereinafter referred to as “diffuser”)	8
Installing/Removing ZHIYUN FIVERAY M20 4-Leaf Barn Doors (hereinafter referred to as “4-leaf barn doors”)	9
Installing/Removing ZHIYUN FIVERAY M20 Honeycomb Grids (hereinafter referred to as “honeycomb grids”)	10
Mounting the Tripod	11
Using with a Camera	11
□ How to Use ZHIYUN CINEPEER CM15	
Buttons and Dials	12
Operation Instruction	13







<input type="checkbox"/> Firmware Upgrade	
<input type="checkbox"/> Product Specifications	
<input type="checkbox"/> Disclaimer and Warnings	
Reading Tips	20
Safe Operation Instructions	21
<input type="checkbox"/> Warranty Card	
Warranty Period	22
Warranty Exclusions	22
Warranty Claim Procedure	22
<input type="checkbox"/> Contact Card	

Brief Introduction

ZHIYUN CINEPEER CM15 is a portable full-color mini LED pocket fill light that features a stylish appearance and compact size. It supports RGB adjustment and offers various creative light effects. The product has the following highlights:

1. Lightweight and portable with simple operation.
2. Allows for adjustable brightness/color temperature/hue/saturation, suitable for a wide range of applications.
3. High color rendering performance, accurately reproducing the true colors of objects.
4. Equipped with DynaVort Cooling System™ for excellent heat dissipation.
5. Offers a variety of RGB light effects for creative shooting scenarios.
6. Supports PD fast charging to charge the light while operating at the same time
7. Various ways to install and use: can be handheld, mounted on a tripod, or attached to a camera's cold shoe mount.

WARNING

-  This product is not waterproof. Prevent contact with any kind of liquid with the ZHIYUN CINEPEER CM15. Never use the product in the rain or a humid environment.
-  If water accidentally enters the device when using, please stop using it immediately and contact the company or authorized maintenance personnel for maintenance, and continue to use it only when the maintenance is finished.
-  Do not expose this product to corrosive chemicals, inflammable and explosive materials.
-  Do not touch the heating part when the product is working to avoid getting burned.
-  Do not wrap or block the fans to avoid cooling effect damage.
-  Do NOT turn the product directly to the eyes to avoid eyesight damage.
-  Do not expose this product to an environment above 40°C .

⚠ Battery safety precautions:

- ① It is strictly prohibited to use batteries that are not provided by ZHIYUN. If you need to replace the battery, please contact ZHIYUN or designated agents. ZHIYUN will not be responsible for any battery accidents or equipment malfunctions caused by using batteries that are not officially provided by ZHIYUN.
- ② If the battery bulges, leaks, or has other abnormalities, please stop using it immediately and contact ZHIYUN customer service or designated agents for further processing.
- ③ Do not completely discharge the battery and store it for a long time to prevent the battery from entering an over-discharged state and causing damage to the battery cell, which may make it impossible to recover and reuse.

BE CAREFUL

1. This product is a high-precision control device. Damage may be caused to the product if dropped or subject to external force, and this may result in malfunction.
2. Please keep your hands dry while using the product and use a soft dry cloth for cleaning.
3. Keep this product out of the reach of children.
4. When not using this product, please disconnect the external power supply.
5. Do not place any other items on top of this product to avoid damage to this product.
6. Protect the product from dust and sand during use.
7. Before storing this product, please make sure it is completely cooled and store it in a dry and ventilated place.
8. Do not disassemble this product on your own. In the event of malfunctions, it should be repaired by ZHIYUN or authorized maintenance personnel.

Product List

Before using this product, please check carefully that all the following items are included in the product package. In case that any item is found missing, please contact ZHIYUN or your local selling agent.



ZHIYUN CINEPEER CM15 Fill Light x1

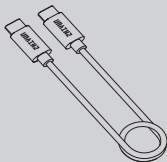

USB Type C Cable x1

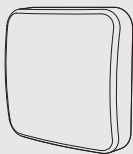

Diffuser x1

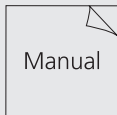

Quick Start Guide x1

Get to Know ZHIYUN CINEPEER CM15

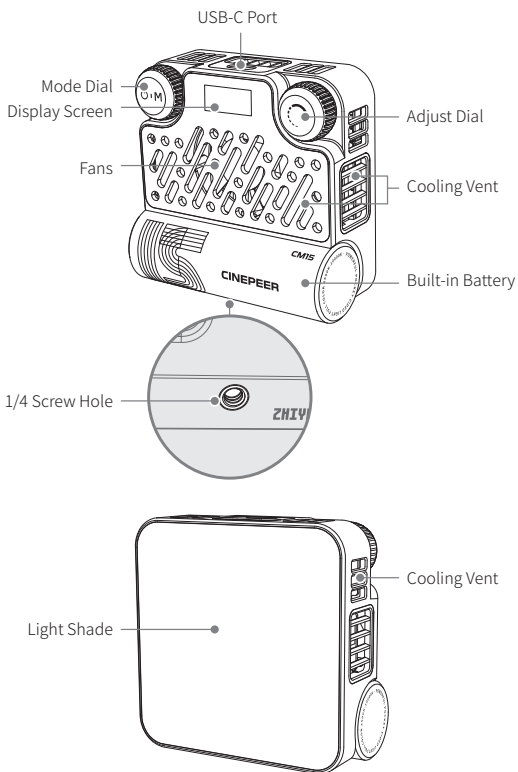

Charging

This product uses a built-in battery to ensure sufficient battery life. You can view the remaining battery level on the display screen. When the battery is low, you can charge it while still using the light using the following method:

Charging Method: Use the provided USB Type-C cable to connect the fill light to a USB charger. It is recommended to use a USB charger that supports the PD (Power Delivery) fast charging protocol. When charging while using the fill light, the USB charger will prioritize powering the fill light, and the remaining power will be used to charge the battery. The maximum PD charging power supported by the battery is 9W.

AC Power
(100-240V)



USB Charger

USB Type-C Cable



- ① It is recommended to fully charge CM15 before using it. Low battery might impair the product performance.
- ② USB chargers are not included in the package.

Installing/Removing the Diffuser

Align the four corners of the diffuser with the ZHIYUN CINEPEER CM15, then install the diffuser onto the fill light. To remove, simply take the diffuser off the fill light.

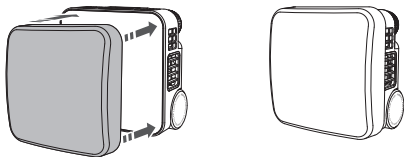

Installing/Removing ZHIYUN FIVERAY M20 Extension Bracket (hereinafter referred to as “extension bracket”)

Installing:

Push the lock switch of the lateral plate upward ① and turn the lateral plate outward ②. Place ZHIYUN CINEPEER CM15 into the extension bracket ③. Finally, Turn the lateral plate inward and apply slight pressure until the lock switch automatically locks ④.

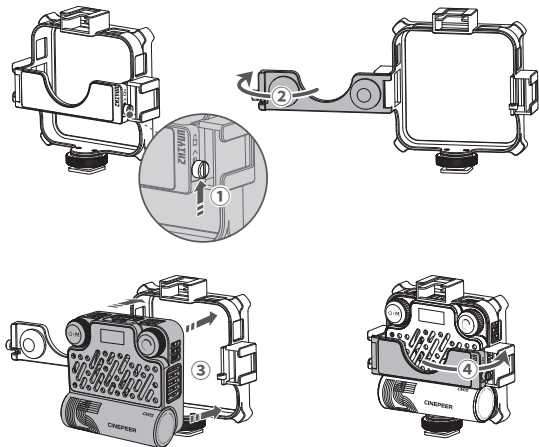

Removing:

Push the lock switch of the lateral plate upward ① and turn the lateral plate outward ② . Remove the ZHIYUN CINEPEER CM15 from the extension bracket ③ . Finally, Turn the lateral plate inward and apply slight pressure until the lock switch automatically locks ④ .

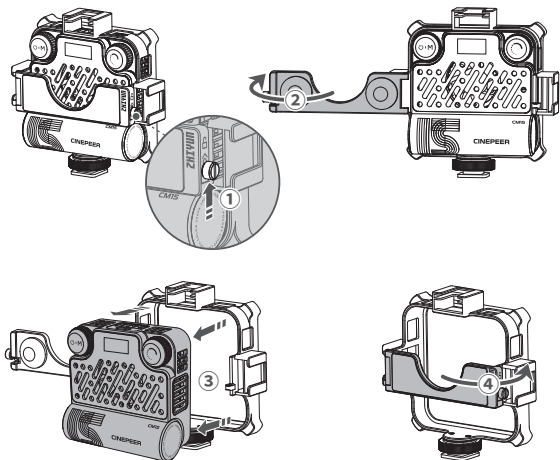

 You need to purchase the extension bracket separately.

Installing/Removing ZHIYUN FIVERAY M20 Diffuser (hereinafter referred to as “diffuser”)

Install the extension bracket onto the ZHIYUN CINEPEER CM15, then align the four corners of the diffuser with the four corners of the extension bracket and attach them. When disassembling, simply remove the diffuser from the extension bracket.

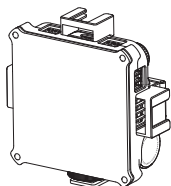
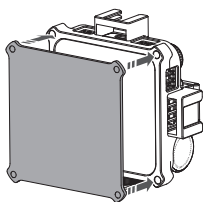

 You need to purchase the diffuser separately.

Installing/Removing ZHIYUN FIVERAY M20 4-Leaf Barn Doors (hereinafter referred to as “4-leaf barn doors”)

Installing:

Install the extension bracket onto the ZHIYUN CINEPEER CM15, then align the four corners of the four-leaf barn doors with the four corners of the extension bracket and attach them ① . You can unfold the four leaves to the appropriate angle ② . Mount the diffuser onto the four-leaf barn doors ③ . When disassembling, simply remove the diffuser and the four-leaf barn doors from the extension bracket in sequence.

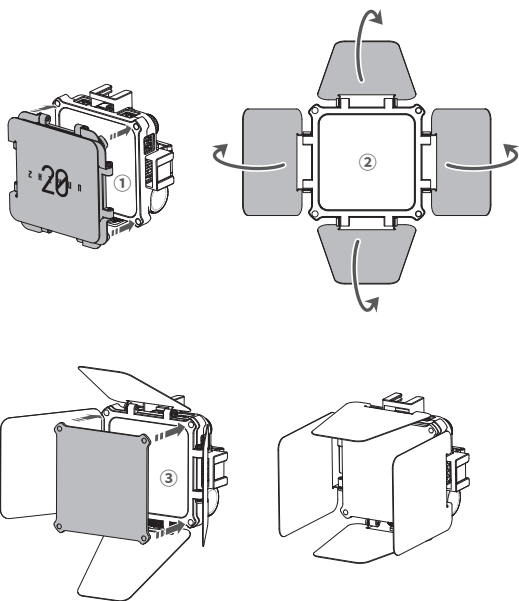

💡 You need to purchase the four-leaf barn doors separately.

Installing/Removing ZHIYUN FIVERAY M20 Honeycomb Grids (hereinafter referred to as “honeycomb grids”)

Install the extension bracket onto the ZHIYUN CINEPEER CM15, then align the four corners of the honeycomb grids with the four corners of the extension bracket and attach them. When disassembling, simply remove the honeycomb grids from the extension bracket.

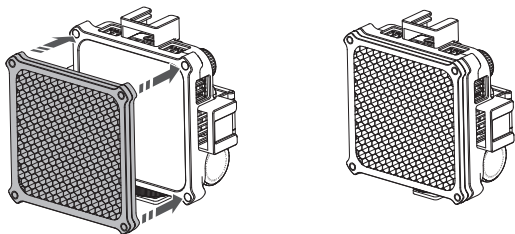

 You need to purchase the honeycomb grids separately.

Mounting the Tripod

Align the screw on the top of the tripod with the 1/4-inch screw hole on the bottom of the fill light, then mount the tripod onto the fill light.

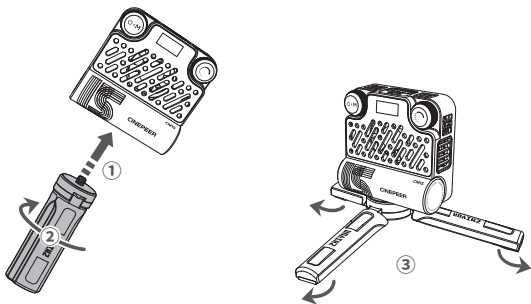

 Tripod is not provided. Please prepare separately.

Using with a Camera

Install the cold shoe mount onto the ZHIYUN CINEPEER CM15, then mount the cold shoe adapter and the fill light assembly onto the camera's cold shoe.

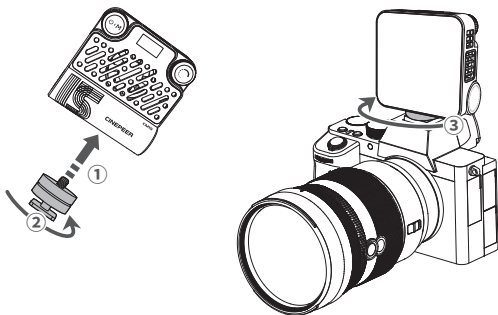

 Cold shoe mount is not provided. Please prepare separately.

⚠ DO NOT stare at the LED chips when the device is operating.

⚠ The IP rating of the outer case is IP20.

Dials



Mode Dial:

Single press+long press: Power on

Long press: Power off

Single press: Switch modes

Double press: Switch to the previous mode

Turn: Switch options (in submenu)

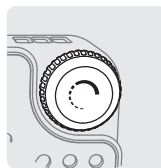

Adjust Dial:

Single press: Quickly adjust the current parameter

Confirm (submenu)

Turn: Adjust the current parameter

Operation Instruction

1. CCT Mode Settings

Single press Mode dial to switch to CCT mode. Turn the Mode dial to switch to brightness/color temperature/Green-Magenta options. Single press/turn the Adjust dial to adjust the chosen parameter.

Brightness adjustment range: 0-100%

Color temperature adjustment range: 2500-10000K

Green-Magenta adjustment range: -10-10

CCT	
BRT:	100°
CCT:	5500K
G/M:	-2

2. HSI Mode Settings

Single press Mode dial to switch to HSI mode. Turn the Mode dial to switch to hue/saturation/intensity options. Single press/turn the Adjust dial to adjust the chosen parameter.

Saturation adjustment range: 0-100%

Hue adjustment range: 0° -360°

Intensity adjustment range: 0-100%

HSI	
DIM:	100%
HUE:	120°
SAT:	100%

3. RGB Mode Settings

Single press Mode dial to switch to RGB mode. Turn the Mode dial to switch to RGB/brightness options. Single press/turn the Adjust dial to adjust the chosen parameter.

RGB adjustment range: 0-100%

Brightness adjustment range: 0-100%

RGB		
R:	100%	
G:	30%	
B:	50%	▼

4. FX Mode Settings

Single press Mode dial to switch to FX mode. Turn the Mode dial to switch to effect/brightness/speed/color temperature options. Single press/turn the Adjust dial to adjust the chosen parameter.

Effect types: SOS, Paparazzi, Candle, Bad Bulb, TV, Lightning, Strobe, Explosion, Welding, CCT Pulse, CCT Loop, CCT Flash, HUE Loop, HUE Pulse, HUE Flash, Police Car, Disco, Fireworks.

Brightness adjustment range: 0-100%

Speed adjustment range: 1-5;

Color temperature adjustment range: 2500-10000K

FX		
FX:	SOS	
DIM:	100%	
SPD:	5	▼

- ① The adjustable parameters vary under different light effects and the operation steps are similar. The “SOS” effect is used as an example to demonstrate the operation steps above.
- ② The parameter values in a single light effect are only effective for that light effect.

5. Menu Settings

Single press Mode dial to switch to menu interface. Turn the Adjust dial to set the interface language and press the Adjust dial once to confirm.

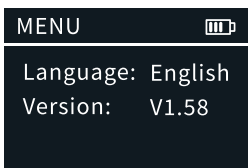

 Under the "MENU" option, you can also check the firmware version information for the ZHIYUN CINEPEER CM15.

You can use "Zhiyun Led Tools" and follow the steps below to perform the ZHIYUN CINEPEER CM15 firmware upgrade.

1. Visit the official website of ZHIYUN (www.zhiyun-tech.com), go to the ZHIYUN CINEPEER CM15 product page, click "Download", find the Zhiyun Led Tools and the firmware and download.
2. Unzip the firmware for the files with the ".ptz" file extension.
3. Connect the USB-C port of ZHIYUN CINEPEER CM15 to the USB port of the computer with the USB Type-C cable.
4. Open "Zhiyun Led Tools", click "Open", and click "Firmware Upgrade". Click "Browse" under "Path" to select the latest firmware downloaded (with the ".ptz" file extension), and click "Upgrade" at the bottom to upgrade firmware. ZHIYUN CINEPEER CM15 will automatically turn off when the upgrade is finished.

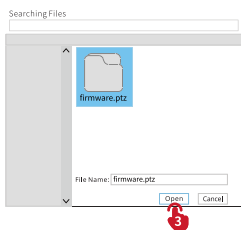
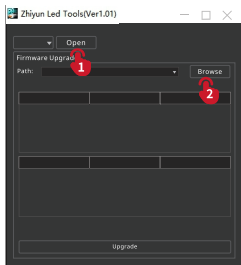
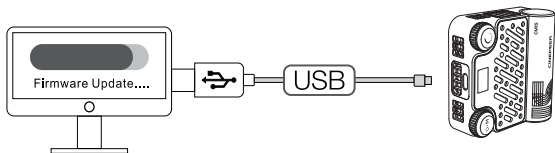

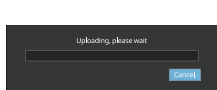
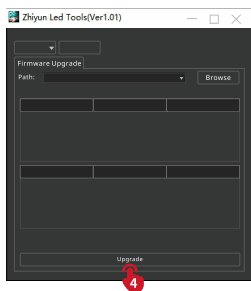

💡 When upgrading, please wait until the screen displays that the upgrade is finished, then you can plug out the USB Type-C cable.

Product Model: PLM106

Max Output Power	15W	
Battery Capacity	2600mAh	
Color Temperature Range	2500K-10000K	
Dimming Range	0-100%	
RGB	0-360°	
CRI/TLCI	CRI \geq 94 TLCI \geq 96	
LED Chip	80pcs	32 pcs RGB +16 pcs warm+16 pcs cool+16 pcs red
Illuminance (Max power, without modifier)	3460(lux)	Lab Data 1
Charging Time (PD fast charging)	1H 30min	Lab Data 2
Runtime (Max power)	35min	Lab Data 3
R Illuminance	204(lux)	
G Illuminance	223(lux)	Lab Data 4
B Illuminance	84(lux)	
Operation Temperature	-10° -40°	
Product Size	78x78x35.75mm	
Product Net Weight	141g	

Lab Data 1: The data is collected under the following conditions: 25°C temperature, indoor illuminance lower than 0.1lux, test distance 0.3m, and the color temperature is set at 4300K with 100% brightness. The illuminance is 3460lux. The actual illuminance varies under different conditions.

Lab Data 2: This data was tested under the condition of an ambient temperature of 25°C, using a 27W PD fast charger. The charging time is 1H 30min. The actual charging time may vary due to different environmental conditions. The lower the charging environment temperature, the smaller the charging current, and the longer the charging time will be extended.

Lab Data 3: This data was tested under the condition of an ambient temperature of 25°C, with the fill light fully charged, in CCT mode, with a color temperature of 4300k, and a brightness of 100%. The continuous working time is 35 minutes. The actual continuous working time may vary due to different usage times of the fill light, the number of battery charge and discharge cycles, and battery activity. The longer the fill light is used, the more battery charge and discharge cycles, the lower the battery activity, and the continuous use time will be shortened accordingly.

Lab Data 4: With 25°C temperature, indoor illuminance lower than 0.1lux, and 1m test distance, set the product at 100% saturation and 100% brightness, and the red/green/blue illuminance is 204 lux/223 lux/84 lux. The actual red/green/blue illuminance varies under different conditions.

The above data is gathered from internal experiments of ZHIYUN laboratories. Under different scenarios, data is different to some extent. Please refer to the actual use.

Thank you for purchasing this product. The information contains herein affects your safety, legitimate rights and obligation. Please read this instruction carefully to ensure proper configuration before use. Failure to read and follow this instruction and warnings herein may result in serious injury to you or bystanders, or damage to your device or property. Guilin Zhishen Information Technology Co., Ltd (hereinafter referred to as "ZHIYUN") reserves all rights for final explanation of this instruction and other documents related to this product. The information is subject to update without notice. Please visit www.zhiyun-tech.com to obtain the latest product information.

By using this product, you hereby signify that you have read this document carefully and that you understand and agree to abide by the terms and conditions herein. You agree that you are solely responsible for your own conduct while using this product, and for any consequences thereof. You agree to use this product only for purposes that are proper and in accordance with all terms, precautions, practices, policies and guidelines ZHIYUN has made and may make available.

ZHIYUN accepts no liability for damage, injury or any legal responsibility incurred directly or indirectly from the use of this product. Users shall observe safe and lawful practices including, but not limited to, those set forth herein.

ZHIYUN™ is the trademark of Guilin Zhishen Information Technology Co., Ltd and its affiliates. All product names or trademarks referred to herein are trademarks or registered trademarks of their respective holders.

Reading Tips

Legends:  Hints and Tips

 Important

Safe Operation Instructions

Read the ENTIRE User Guide to become familiar with the features of this product before operating. Failure to operate the product correctly can result in damage to the product or personal property and cause serious injury. This is a sophisticated product. It must be operated with caution and common sense and requires some basic mechanical ability. Failure to operate this product in a safe and responsible manner could result in injury or damage to the product or other property. This product is not intended for use by children without direct adult supervision. DO NOT use with incompatible components or in any way otherwise as mentioned or instructed in the product documents provided by ZHIYUN. The safety guidelines herein contain instructions for safety, operation and maintenance. It is essential to read and follow all of the instructions and warnings in the User Guide, prior to assembly, setup or use, in order to operate the product correctly and avoid damage or serious injury.

Warranty Period

1. Customers are entitled to replacement or free repair service in case of quality deficits found in the product within 15 days upon receipt of the product.
2. Customers are entitled to free repair service from ZHIYUN for any product proven defective in material or workmanship that results in product failure during normal consumer usage and conditions within the valid warranty period, which is 12 months counting from the date of selling. However, warranty period varies by product component and country of purchase. Please contact our after-sales service team on ZHIYUN official website or your place of purchase for detailed warranty information.

Warranty Exclusions

1. Products subjected to unauthorized repair, misuse, collision, neglect, mishandling, soaking, accident, and unauthorized alteration.
2. Products subjected to improper use or whose labels or security tags have been torn off or altered.
3. Products whose warranty has expired.
4. Products damaged due to force majeure, such as fire, flood, lightning, etc.

Warranty Claim Procedure

1. If failure or any problem occurs to your product after purchase, please contact a local agent for assistance, or you can always contact ZHIYUN's customer service through email at info@zhiyun-tech.com or website at www.zhiyun-tech.com.
2. Your local agent or ZHIYUN's customer service will guide you through the whole service procedure regarding any product issue or problem you have encountered. ZHIYUN reserves the right to reexamine damaged or returned products.

Customer Information

Customer Name:

Phone Number:

Address:

Sales Information

Sales date:

Product Serial Number:

Distributor Name:

Distributor's Contact Number:

First Maintenance Record

Service Date:

Repairman Signature:

Cause of Problem:

Service Result:

 Solved Unsolved Refunded/Replaced



Website



Weibo



Vimeo



Google+



Facebook
(Zhiyun Support)



Facebook
(Zhiyun Tech)



Youku



Youtube



Wechat



Instagram

Tel: +86 400 900 6868

USA Hotline: +1 808-319-6137,9:00-18:00 GMT-7,Mon-Fri

Europe Hotline: +49 (0) 61018132180,10:00-17:00 GMT+1,Mon-Fri

Web: www.zhiyun-tech.com

E-mail: info@zhiyun-tech.com

Address: 09 Huangtong Road, Tieshan Industrial Zone, Qixing District, Guilin, 541004, Guangxi, China

Certificate of Quality

This product is confirmed to meet quality standards and permitted for sale after strict inspection.

QC Inspector: _____



For full product information, please visit ZHIYUN's official website: Content on www.zhiyun-tech.com is subject to update without notice.

ZHIYUN™ is a trademark of ZHISHEN

All product names or brands referred to hereunder may be trademarks or registered trademarks of their respective holders.

Copyright © 2024 ZHISHEN. All rights reserved.

ZHIYUN-TECH.COM